

FS-1 Series Light Duty Foot Switches

Features

- Low cost foot switch for light to medium duty applications
- Available in standard model and ergonomic (front hinged) model
- Black painted steel housing with nonskid base pad and foot treadle pad
- UL/CSA/CE/CCC certified

Specifications

Operating Frequency	60 ops/min
Insulation Resistance	>100MΩ@500V DC
Contact Resistance	<25mΩ (initial)
Rated Current/Voltage	10A/15A 250VAC
Dielectric Strength	1000VAC for 1 min between current carrying parts 2500VAC for 1 min between non-current carrying parts
Service Life	Mechanically 1 x10 ⁶ (operations) Electrically 5 x10 ⁵ (operations)
Operating Temperature	-20°C to +80°C (-4°F to + 176°F)
Degree of Protection	IP20/NEMA 1 (IP68/NEMA 6,6P available upon request)

Selection Guide:

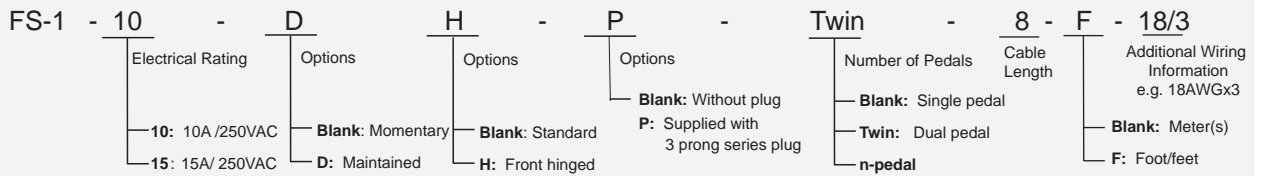

Dimensions:

- FS-1-15 (Not wired)
- FS-1-10-2-18/3 (Prewired 2 meters 18AWGx3 1NO)
- FS-1-10-P-8F-18/3 (Prewired 8ft 18AWGx3 with series plug)



Standard model

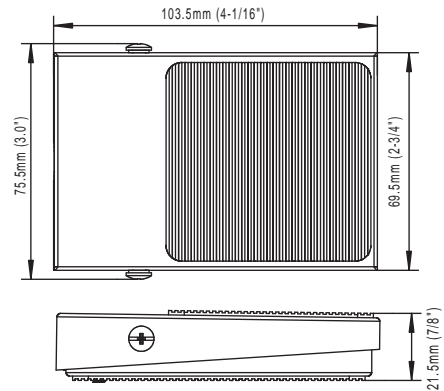

- FS-1-15-H (Front hinged, not wired)
- FS-1-10-H-2-18/3 (Front hinged, prewired 2 meters 18AWGx3 1NO)



Front hinged (suffix add -H)

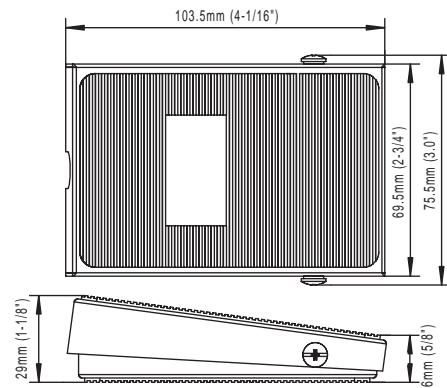

FS-1 Series Light Duty Foot Switches

FS-1-15-D (Not wired)
 FS-1-10-D-2-18/3 (Prewired 2 meters 18AWGx3 1NO)

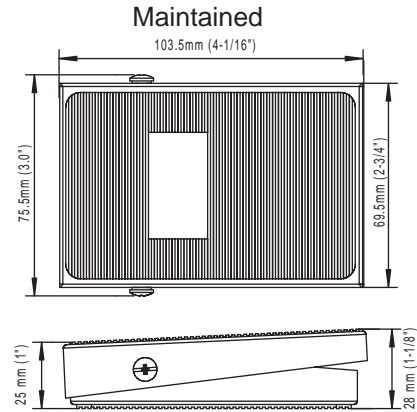

FS-1-15 (Twin) (Not wired)
 FS-1-10 (Twin)-2-18/4 (Prewired 2 meters 18AWGx4 1NOx2)

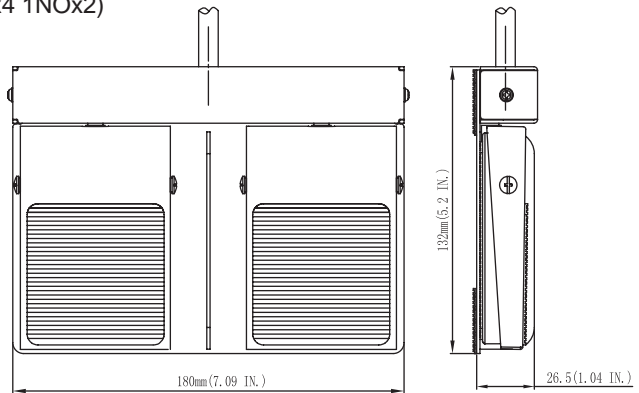

FS-1G-15 (Not wired)
 FS-1G-10-2-18/3 (Prewired 2 meters 18AWGx3 1NO)

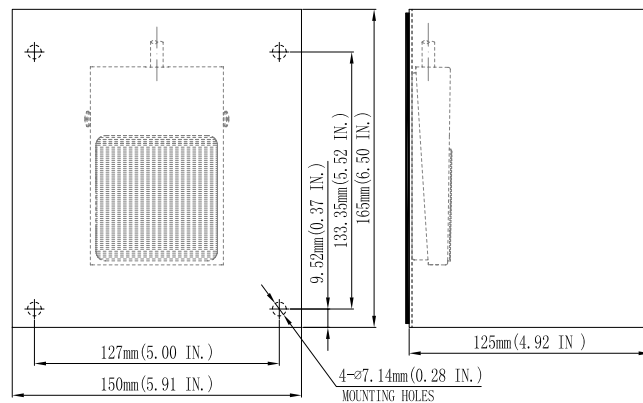

FS-1 Series Light Duty Foot Switches

FS-1G-15 (Twin) (not wired)
 FS-1G-10 (Twin)-2-18/4 (prewired 2 meters 18AWGx4 1NO)

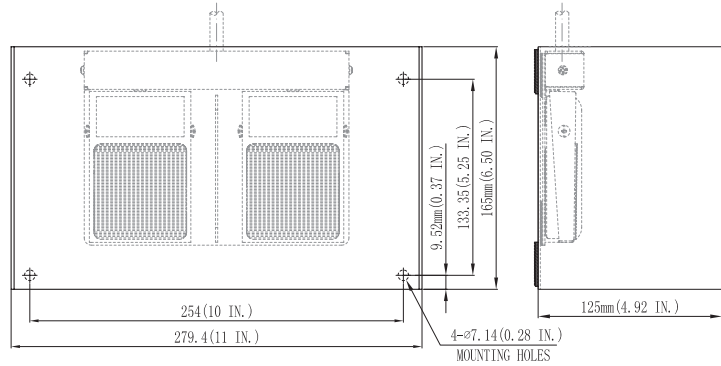

FS-1G

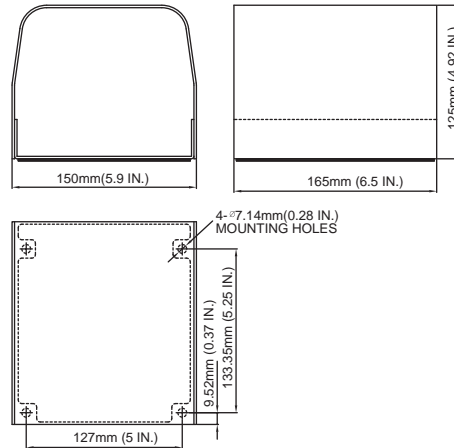

FS-TG

