

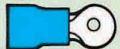

















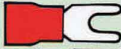

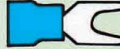











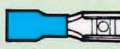





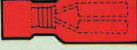



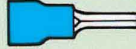
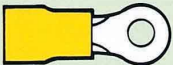
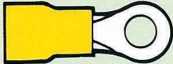



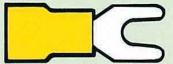









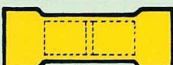

Insulated Terminals

ITEM NO.	AWG 22-16 DIN 0.5-1	STUD SIZE	ITEM NO.	AWG 16-14 DIN 1.5-2.5	STUD SIZE
RING TERMINALS			RING TERMINALS		
VF 1.25-3		#6/3.7mm	VF 2-3		#6/3.7mm
VF-1.25-3S		#4/3.2mm	VF 2-3S		#4/3.2mm
VF-1.25-4		#8/4.3mm	VF 2-4		#8/4.3mm
VF-1.25-5		#10/5.3mm	VF 2-5		#10/5.3mm
VF-1.25-6		#1/4"/6.4mm	VF 2-6		#1/4"/6.4mm
VF-1.25-8		#5/16"/8.4mm	VF 2-8		#5/16"/8.4mm
FORKED SPADE			FORKED SPADE		
VF-1.25-3Y		#6/3.7mm	VF 2-3Y		#6/3.7mm
VF-1.25-4Y		#8/4.3mm	VF 2-4Y		#8/4.3mm
VF-1.25-5Y		#10/4.3mm	VF-25Y		#10/5.3mm
VF-1.25-6Y		#1/4"/6.4mm	VF 2-6Y		#1/4"/6.4mm
MALE DISCONNECTORS			MALE DISCONNECTORS		
3110A		TAB 2.8mm	3120A		TAB 2.8mm
4110A		TAB 4.8mm	4120A		TAB 4.8mm
5110A		TAB 6.4mm	5120A		TAB 6.4mm
FEMALE DISCONNECTORS			FEMALE DISCONNECTORS		
3110B		TAB 2.8mm	3120B		TAB 2.8mm
4110B		TAB 4.8mm	4120B		TAB 4.8mm
5110B		TAB 6.4mm	5120B		TAB 6.4mm
BULLET DISCONNECTORS			BULLET DISCONNECTORS		
F1.25A		4mm BULLET	F 2A		4mm BULLET
F1.25B		4mm BULLET	F 2B		4mm BULLET
BUTT DISCONNECTORS			BUTT DISCONNECTORS		
BF-1.25			BF-2		
PIN DISCONNECTORS			PIN DISCONNECTORS		
PIN-1.25		TAB 1.9mm	PIN-2		TAB 1.9mm

Insulated Terminals

ITEM NO.	AWG 12-10 DIN 4-6	STUD SIZE
RING TERMINALS		
VF 5.5-4		#8/4.3mm
VF 5.5-5		#10/5.3mm
VF 5.5-6		#1/4"/6.4mm
VF 5.5-8		#5/16"/8.4mm
VF 5.5-10		#3/8"/10.5mm
FORKED SPADE		
VF 5.5-4Y		#8/4.3mm
VF 5.5-5Y		#10/5.3mm
VF 5.5-6Y		#1/4"/6.4mm
MALE DISCONNECTORS		
3150A		TAB 2.8mm
4150A		TAB 4.8mm
5150A		TAB 6.4mm
FEMALE DISCONNECTORS		
3150B		TAB 2.8mm
4150B		TAB 4.8mm
5150B		TAB 6.4mm
BULLET DISCONNECTORS		
F5.5A		5mm BULLET
F5.5B		5mm BULLET
BUTT DISCONNECTORS		
BF-5.5		
PIN DISCONNECTORS		
PIN-5.5		TAB 2.8mm

ITEM	TYPE	RANGE SIZE.
FULL INSULATED		
RF250F		Wire Range 22-16 / TAB 6.4mm
BF250F		Wire Range 16-14 / TAB 6.4mm
PIGGY BACK		
MF-1.25		Wire Range 22-16 / TAB 6.4mm
MF-2		Wire Range 16-14 / TAB 6.4mm
MF5.5		Wire Range 12-10 / TAB 6.4mm
STRIPPING QUICK SPLICE		
878100		
878101		
878201		



Insulated Terminals

ITEM NO	WIRE RANGE	STUDE SIZE
VF-1.25-3M	AWG 22-16 DIN 0.5-1	3.7mm
VF-1.25-4M	AWG 22-16 DIN 0.5-1	4.15mm
VF-1.25-10	AWG 22-16 DIN 0.5-1	10.4mm
VF-2-3M	AWG 16-14 DIN 1.5-2.5	3.65mm
VF-2-4M	AWG 16-14 DIN 1.5-2.5	4.2mm
VF-2-10	AWG 16-14 DIN 1.5-2.5	10.3mm
VF-3.5-4	AWG 12-10 DIN 2.5-4	4.3mm
VF-3.5-5	AWG 12-10 DIN 2.5-4	5.45mm

RING TERMINALS

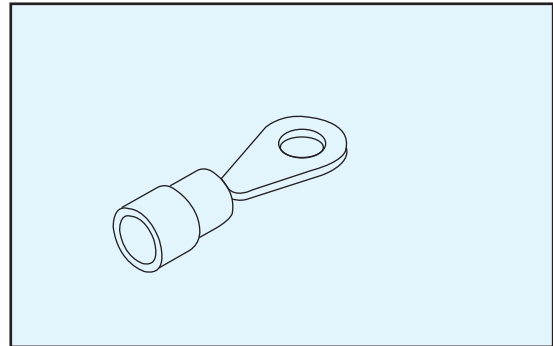

VF-1.25-3SY	AWG 22-16 DIN 0.5-1	3.7mm
VF-1.25-4SY	AWG 22-16 DIN 0.5-1	4.4mm
VF-2-3SY	AWG 16-14 DIN 1.5-2.5	3.7mm
VF-2-4SY	AWG 16-14 DIN 1.5-2.5	4.5mm
VF-3.5-4Y	AWG 12-10 DIN 2.5-4	4.3mm
VF-3.5-5Y	AWG 12-10 DIN 2.5-4	5.4mm
VF-5.5-3SY	AWG 12-10 DIN 4-6	3.7 mm

FORKED SPADE

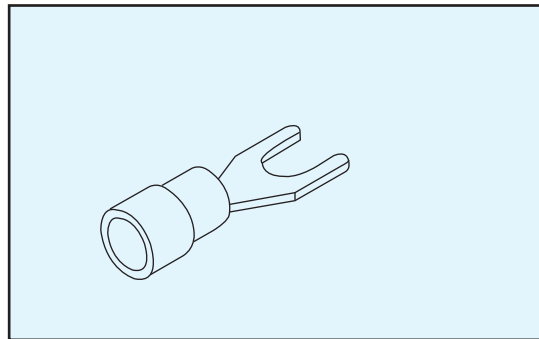

YF-250F	AWG 12-10	TBA
	DIN 4-6	6.4 mm

FULL INSULATED

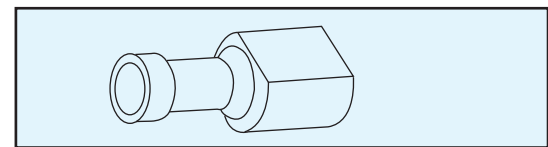

SPADE TERMINALS

UNIT:mm

ITEM NO	B	F	E	••D
BT1-14V	3.0	14	10	4.1
BT1-18V	2.3	18	10	4.1
BT2-9V	2.8	9	10	4.5
BT2-18V	2.3	18	10	4.5
BT2-18V	3.0	18	13	6.5

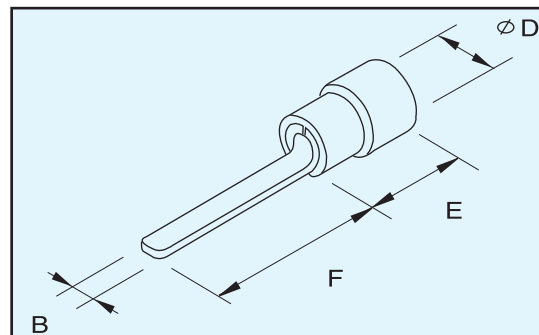

INSULATED CORD END TERMINAL



■ DIMENSIONS :

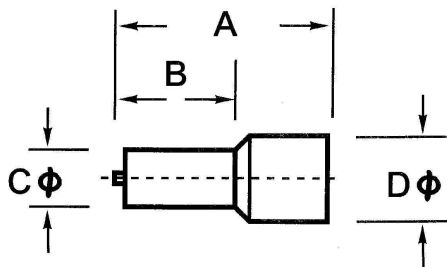

■ MATERIAL SPECIFICATION :

- INSULATION : POLYAMID66, -50°C~ + 105°C
- MATERIAL : E-COPPER, TINNED

ITEM NO	CONDUCTOR mm	A	B	C •	D •	COLOR
CE002506	0.25	10.0	6.0	1.05	2.5	L.BLUE
TURKIS		12.0	8.0			
CE003406	0.34	10.0	6.0	1.10	2.5	TURKIS
CE003408		12.0	8.0			
CE005006	0.50	12.0	6.0	1.30	3.2	ORANG E
CE005008		14.0	8.0			
CE005010		16.0	10.0			
CE007506	0.75	12.0	6.0	1.50	3.4	WHITE
CE007508		14.0	8.0			
CE007510		16.0	10.0			
CE007512		18.0	12.0			
CE010006	1.00	12.0	6.0	1.70	3.6	YELLOW
CE010008		14.0	8.0			
CE010010		16.0	10.0			
CE010012		18.0	12.0			
CE015006	1.50	12.0	6.0	2.00	4.1	D. RED
CE015008		14.0	8.0			
CE015010		16.0	10.0			
CE015012		18.0	12.0			
CE015018		24.0	18.0			
CE025008	2.50	14.0	8.0	2.50	4.8	BLUE
CE025010		16.0	10.0			
CE025012		18.0	12.0			
CE025018		24.0	18.0			
CE040010	4.00	17.0	10.0	3.20	5.5	GREY
CE040012		20.0	12.0			
CE040018		26.0	18.0			
CE060012	6.00	22.0	12.0	3.90	7.0	BLACK
CE060018		26.0	18.0			
CE100012	10.00	22.0	12.0	4.90	8.4	IVORY
CE100018		28.0	18.0			
CE160012	16.00	24.0	12.0	6.20	9.6	GREEN
CE160018		28.0	18.0			
CE250016	25.00	28.0	16.0	7.70	12.0	BROWN
CE250018		30.0	18.0			
CE250022		35.0	22.0			
CE350012	35.00	26.0	12.0	8.70	13.5	BEIGE
CE350016		30.0	16.0			
CE350018		35.0	18.0			
CE350025		39.0	25.0			
CE500020	50.00	36.0	20.0	10.9	16.0	OLIVE
CE500025		40.0	25.0			
CE700021	70.00	37.0	21.0	14.3	17.2	YELLOW
CE950025	95.00	44.0	25.0	15.5	19.2	RED
CE120027	120.00	48.0	27.0	17.6	21.4	BLUE
CE150032	150.00	58.0	32.0	20.5	25.0	YELLOW